

The following features are available in this PDF document.



Quick Keyword Search

Enter the keyword in the search box and hit the search button



Quick Jump between Chapters

Click the title of a specific chapter on the Contents to jump to it

*Reading software such as Adobe Reader is needed to support the functions above.



CRANE 3S

User Guide

Contents

■ Product List	
Product List.....	1
■ Get to Know CRANE 3S	
Get to Know CRANE 3S.....	2
Port Introduction.....	3
■ Preparing and Charging the Batteries	
Charger and Batteries Description.....	4
Charging Procedure.....	5
■ Installation and Balance Adjustment	
Tripod Installation.....	6
Battery Installation.....	6
Camera Installation.....	6
Control Cable Connection.....	8
Balance Adjustment.....	10
■ How to Use	
Buttons Description.....	12
Motor Torque Adjustment.....	13
Operation Mode Description.....	13
TransMount 3S EasySling Handle Installation and Detachment.....	16
TransMount CRANE 3S SmartSling Handle.....	17
Installation and Detachment.....	17
Extension Arm Installation and Detachment.....	18
Manual Angle Lock.....	20
■ APP Operations	

Download APP	21
How to Connect Stabilizer to Smartphone	21
Overview of the Main Functions.....	21
■ Calibration and Firmware Upgrade	
When do you need to calibrate the stabilizer?	22
Initialization Method.....	22
Six-side Calibration	22
Motor Fine-tuning	23
Stabilizer Firmware Update	24
■ Product Specifications	
■ Disclaimer and Warning	
Reading Tips.....	27
Warnings.....	27
Safe Operation Guidelines	27
■ Warranty Terms	
Warranty Period	30
Warranty Exclusions.....	30
Warranty Claim Procedure.....	30
■ Contact Card	

Product List

The product package comes with the following items. In case any item is found missing, please contact ZHIYUN or your local selling agent.

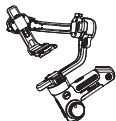

CRANE 3S Stabilizer x 1

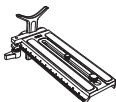

Quick Release Plate x 1

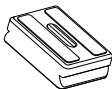

Camera Backing Base x 1



Lens Support Tube x 2

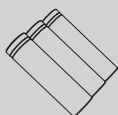

18650 Li-ion Battery x 3

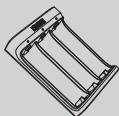

Battery Charger x 1



Tripod x 1



Extension Arm and Rubber Cover x 1

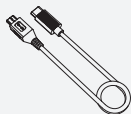

Type-C to Micro USB
Camera Control Cable x 1

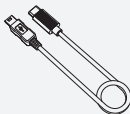

Type-C to Mini USB
Camera Control Cable x 1

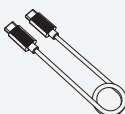

Type-C to Type-C Camera
Control Cable x 1

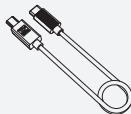

Type-C to Multi USB
Camera Control Cable x 1

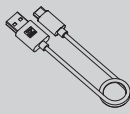

USB Type-C Firmware
Update Cable x 1



1/4-20 Screw x 3



M3 Screw x 6



Manual

Quick Start Guide x 1



Storage Case x 1



Wrench x 3

M1.3
M2.5
M4



Sling Handle Adapter
Base x 1



TransMount 3S
EasySling Handle x 1



TransMount CRANE 3S
SmartSling Handle x 1

- !** ① CRANE 3S-E Package contains TransMount 3S EasySling Handle.
② CRANE 3S Package contains TransMount CRANE 3S SmartSling Handle.

Get to Know CRANE 3S

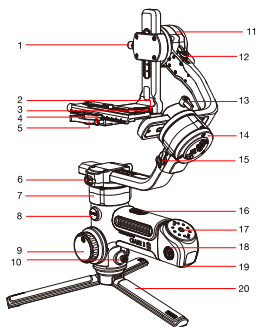

1. Tilt Axis Thumb Screw
2. Type-C Camera Control Port
3. Quick Release Plate Base Latch
4. Quick Release Plate Safety Lock
5. Quick Release Plate Latch
6. Pan Axis Latch
7. Pan Axis Motor
8. DC-IN Charging Port
9. Follow Focus Wheel
10. Joystick
11. Tilt Axis Motor
12. Tilt Axis Latch
13. Roll Axis Thumb Screw
14. Roll Axis Motor
15. Roll Axis Latch
16. Battery Compartment Cover Switch
17. 3/8" Screw Hole
18. 1/4" Screw Thread with Crown Gear
19. Base Pin

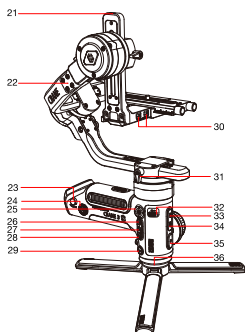

20. Tripod
21. 1/4" Extension Screw Hole
22. Extension Arm Mounting Base
23. TransMount CRANE 3S SmartSling Handle Security Lock
24. 1/4" Screw Thread with Crown Gear
25. Power Button & Mode Indicator Lights
26. POV Button
27. Shutter Button
28. Record Button
29. MODE Button
30. Zoom/Focus Motor Port*2
31. Pan Axis Thumb Screw
32. FN Button
33. USB-A Power Output Port
34. Type-C Firmware Update Port
35. Trigger Button
36. 3/8" Screw Hole

Port Introduction

No.	Port Type	Function	Output	Input
1	Type-C Camera Control Port	Camera control	5V1A	NA
2	Zoom/Focus Motor Port	TransMount CRANE 3S Servo Zoom & Focus Motors connection	8.7V2A	NA
3	DC-IN Charging Port	TransMount PowerPlus Battery Pack connection	/	9.8-25.2V
4	USB-A Power Output Port	External device charging	5V1A	NA
5	Type-C Firmware Update Port	Firmware update	/	/
6	Base Pin	TransMount CRANE 3S SmartSling Handle connection	5V0.5A	NA

When using CRANE 3S for the first time, please fully charge and activate the batteries with the dedicated charging device contained in the package to ensure normal use of the product.

Charger and Batteries Description

Charger Specifications

Name: 18650 Battery Charger (three slots)

Model: CH18650-3B

Input: 5V=2400mA

Output: 4.2V=800mA*3

● The LED indicator shines solid red when charging.

● The LED indicators shines solid blue when fully charged.

Battery Specifications

Name: 18650 Li-ion Battery

Model: IMR 18650 MP

Capacity: 2600mAh

Voltage: 3.6V

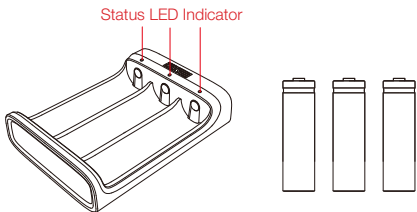

- ⚠️ ① The stabilizer is equipped with batteries of high energy density, which may cause fire, economic loss or personal injury when improperly stored or handled. Please read the disclaimer and warning herein as well as the description on the battery label carefully before using the batteries.
- ② Please use batteries provided or approved by ZHIYUN only. ZHIYUN will not take any responsibility for explosion, fire and/or accidents caused by non-ZHIYUN batteries.

When the batteries are not in use, please make sure to put them in the battery slot of the package or in plastic storage cases (the storage case needs to be purchased separately).

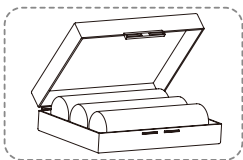
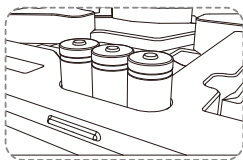

Charging Procedure

1. Insert the batteries into the charger in the right direction (positive/negative end) accordingly.
2. Connect the charger to the adapter via the USB Type-C cable.
3. Plug the adapter into a power outlet to start charging.

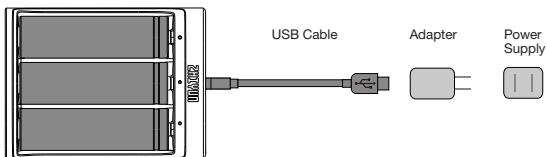

- ① Due to the differences of the charger itself, charging the batteries may fail when the power supply is insufficient (for instance, when the current of the adapter is lower than 500mA). Conditions may vary depending on the specific chargers used. It is recommended to use an adapter with a higher current capacity.
 - ② The battery cannot be charged through the USB port on the stabilizer.
- ⚠ ① Please use a qualified standard 5V/ $\geq 2000\text{mA}$ adapter for battery charging; charging time depends on the maximum input current of the adapter.
 - ② This stabilizer comes standard with three high-discharge-rate ZHIYUN batteries. Use only ZHIYUN batteries or ZHIYUN-approved batteries.
 - ③ Please make sure the three batteries are fully charged. Undercharged batteries can cause stabilizer malfunction.

Tripod Installation

Mount the tripod to the bottom of the stabilizer, then unfold the tripod on a flat surface.

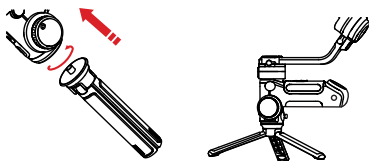

- Place one tripod leg in parallel with the handle of the stabilizer to achieve maximum stability.

Battery Installation

Unlock the battery compartment cover and remove it, then insert three 18650 lithium batteries in the right direction(positive/negative end).

Please put the lifting strap at the bottom of the battery compartment for easy lifting of the batteries.

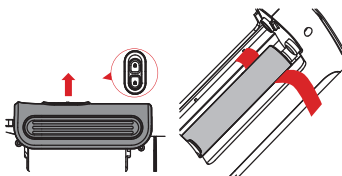

Camera Installation

- ① Each axis of the stabilizer is equipped with a latch. You can use these latches to lock the axes for convenient installation and storage.

Locked for installation

Locked for storage

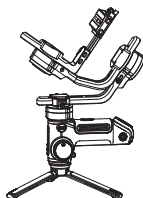
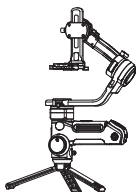
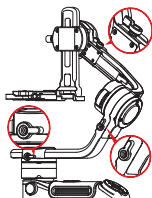

② The axis latches on the stabilizer feature three locking stages: unlocked stage, semi-locked stage, locked stage. Set the latches to unlocked stage when using the stabilizer. During setup, storage and transportation of the stabilizer, users can choose to set the latches to semi-locked stage or locked stage according to their needs. Please set the latches to semi-locked stage before setting them to locked stage to avoid damaging the stabilizer.

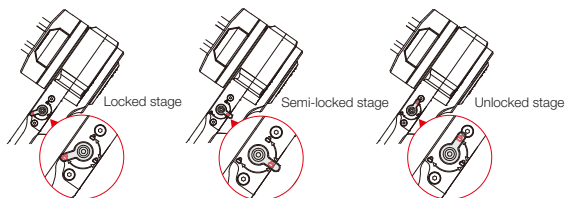

1. Mount the camera on the quick release plate and tighten the screws at the bottom.

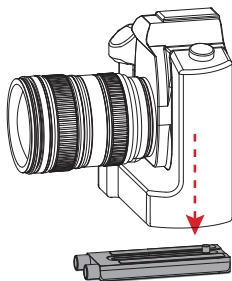

2. Adjust the lens support on the quick release plate to ensure the stability of the lens. (Please mount the lens support according to the actual camera-lens combo.)

3. Slide the quick release plate to the stabilizer and then lock the quick release plate latch.

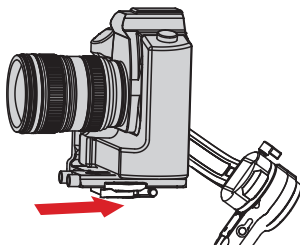

- 💡 The 1/4" screw and 3/8" screw are mounted on the quick release plate by default. It's recommended to tighten the two screws when mounting a cinema camera, and 1/4" screw when mounting a DSLR or mirrorless camera.

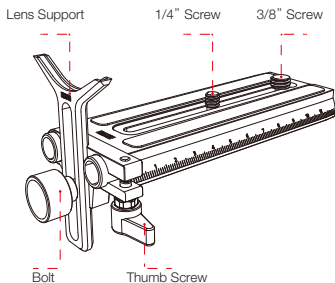

Control Cable Connection

Connect the camera port and the stabilizer's camera control port via a provided camera control cable in the package.

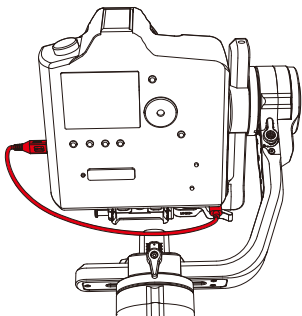

Connector Type	Type-C to Micro USB LN-MBUC-A01		Type-C to Mini USB LN-NBUC-A01		Type-C to Type-C LN-UCUC-A01		Type-C to Multi USB LN-UCUS-A01
Camera Port Type	Micro USB		Mini USB		Type-C		Multi USB
Camera Model	Nikon	Canon			Panasonic	Nikon	Sony
	D850	5D Mark IV	6D Mark II	EOS R	GH5	Z6	A7RM3
Photo	√	√	√	√	√	√	√
Video	√	√	√	√	√	√	√
Live Preview	√	√	√	×	×	×	×
AV	√	√	√	√	√	√	×
TV	√	√	√	√	√	√	×
ISO	√	√	√	√	√	√	×
EV	√	√	√	√	√	√	×
Electronic Focus	√	√	√	√	√	√	×
Electronic Zoom	×	×	×	×	×	×	√

How to select camera brand:

Method 1: Enter CRANE 3S page in ZY Play, and find "Camera Brand" in "Settings" in the upper-right corner, then select the corresponding camera brand consistent with the product used.

Method 2: When connecting with a SmartSling Handle, you can find "camera" in the menu and select the corresponding camera brand consistent with the product used.

- ① Please check the website for complete compatibility list.
- ② When controlling a Sony camera via a control cable, please power on the stabilizer before powering on the camera. Please make sure the camera is fully charged. The optical zoom is available if using a motorized lens, and the digital zoom is available if using a non-motorized lens. You can set in the camera menu.
- ③ For the full camera compatibility list, please visit ZHIYUN official website www.zhiyun-tech.com to check the CRANE 3S Camera Compatibility List.

Balance Adjustment

💡 To facilitate the adjustment procedure, we recommend locking the three axes before the adjustment and unlock and adjust them one by one.

1. Unlock the tilt axis and Quick Release Plate Latch, push the camera to move forward or backward until the camera can stay still and almost level with its lens facing front (as shown below). Complete this step by tightening up Quick Release Plate Latch.

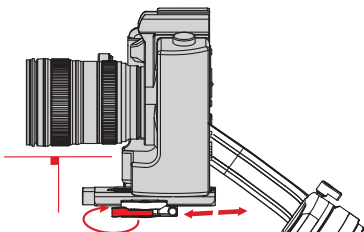

2. Make the lens face up, slightly loosen the thumb screw of the tilt axis, and push the camera to move upward or downward until the camera can stay still with the lens facing up. Complete this step by tightening up the thumb screw.

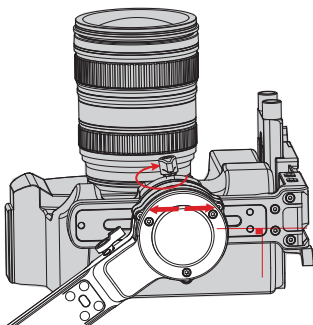

3. Unlock the roll axis, and slightly loosen the roll axis thumb screw under the quick release plate, push the camera to move left or right until the camera can stay still and horizontal to the ground. Complete this step by tightening up thumb screw.

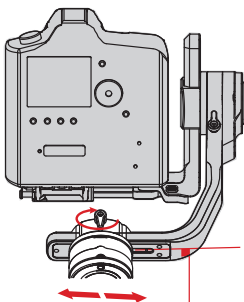

4. Unlock the pan axis, slightly loosen the thumb screw on it, then adjust the pan axis until it stays still and horizontal to the ground. Complete this step by tightening up thumb screw.

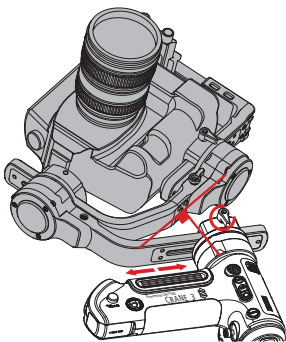

Buttons Description

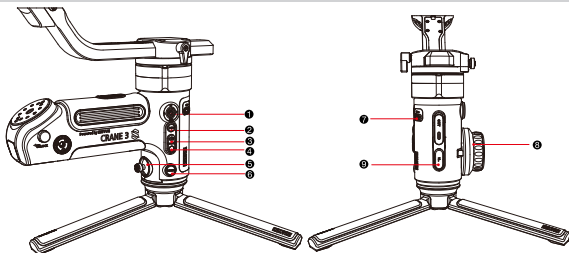
**1** Power Button & Indicator Lights

Power Button:

- Press and hold Power Button for 3 seconds to power on or off the stabilizer.
- Single press to view battery level.

Indicator Lights:

- PF indicator shines solid to indicate that the current operation mode is Pan Following mode.
- L indicator shines solid to indicate that the current operation mode is Locking mode.
- POV indicator shines solid to indicate that the current operation mode is Point of View mode.
- F indicator shines solid to indicate that the current operation mode is Following mode.
- To view battery level, single press Power Button when the device is on and then the LED indicator will blink for 2 seconds.
One indicator blinking: 0-25% battery level
Two indicators blinking: 25%-50% battery level.
Three indicators blinking: 50%-75% battery level.
Four indicators blinking: 75%-100% battery level.

2 POV Button

- Single press to enter POV mode and then single press again to enter Pan Following mode.
- Double press to enter Vortex mode and then single press to enter POV mode.
- Press and hold to enter GO mode and then release the button to enter Pan Following mode.

3 Shutter Button

- Half press to enable automatic zoom function of the camera.

 * For installation method of TransMount CRANE 3S Servo Focus Motor, please check instruction that comes with it. Note:

- ① When powering on the stabilizer, please hold the camera with one hand in case of malfunctioned rotation.
- ② When powering on, avoid shaking of the stabilizer hand grip which may lead to start-up failure.

- Full press to take photo
- 4** Record Button
 - Single click to start/stop video recording.
 - 5** Joystick
 - Four-way direction control of the camera/ lens on the stabilizer (Invalid in GO mode and POV mode).
 - 6** MODE Button
 - Single press to switch between Pan Following mode and Locking mode.
 - Long press MODE button to enter or exit standby mode.
 - 7** FN Button
 - Slide to access predetermined menu option.
 - 8** Follow Focus Wheel
 - The Follow Focus Controller controls the TransMount CRANE 3S Servo Focus Motor by default. Users can switch from mechanical follow focus to digital follow focus on the menu of SmartSling Handle.
 - 9** Trigger Button (front F button)
 - Single press or press and hold the button to enter Following mode; Press again or release the button to enter Pan Following mode.
 - Double press to reset motor position (Invalid in POV mode and Vortex mode)
 - Triple press to make the pan axis rotate 180° while the operation mode remains unchanged (invalid in L mode).

Motor Torque Adjustment

Motor torque of the stabilizer needs to be adjusted to adapt the stabilizer to cameras and lens of different weight for optimal user experience.

Motor torque level can be adjusted in the following ways:

1. Enter corresponding product page of CRANE 3S in ZY Play and then select motor torque level according to your needs in Setting in the top right corner
2. Single press Menu button on SmartSling Handle and rotate the dial to "motor", then select motor torque level according to your needs.

It is recommended for users to use the auto torque adjustment function of the stabilizer to set motor torque level. When using this function, please follow the tips below:

- 💡 ① Before auto adjust torque level, make sure to release the three axis lock switches and put the stabilizer on a flat surface in an upright manner.
- ② Please readjust torque level after switching to another setup.

Operation Mode Description

- 💡 Motors circled in red are free to move in line with the movement of the stabilizer handle while motors circled in grey are locked.

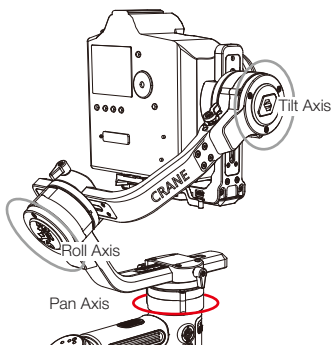

Pan Following Mode (PF): Single press MODE Button to enter

The camera pans left/right following the movement of the stabilizer while the tilt and roll axes are locked. Push the joystick to control the camera to tilt or pan.

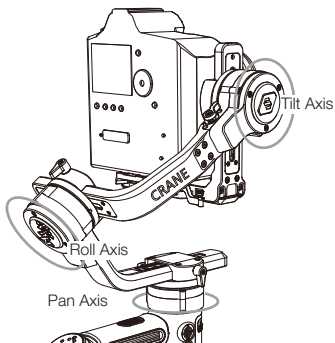

Locking Mode (L): Single press MODE Button to enter

This mode locks the movement of all three axes to keep the camera fixed on a shooting direction. Pushing the joystick up/down and left/right allows manual control of the tilt axis and pan axis.

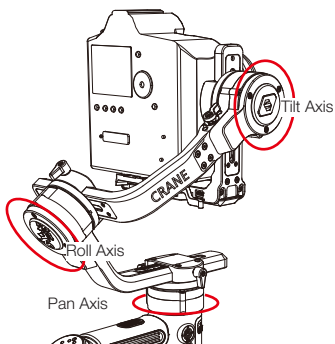

Point of View Mode (POV): Single press POV Button to enter

All three motors move following the movement of the stabilizer.

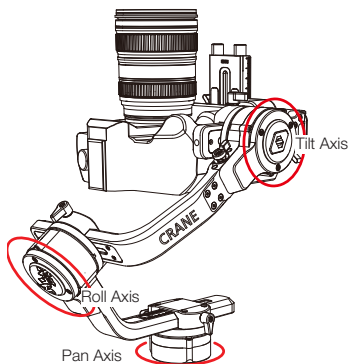

Vortex Mode (V): Double press POV Button to enter
Tilt axis motor rotates 90° angle upward while tilt axis, roll axis and pan axis motor move following the movement of the handle. Push joystick to the left/right to rotate pan axis arm.

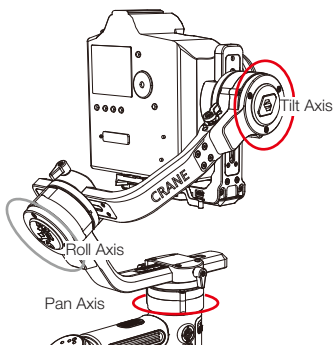

Following Mode (F): Single press or press and hold Trigger (F) Button to enter
The camera pans and tilts following the movement of the stabilizer. Pushing the joystick left/right allows manual control of the roll axis.

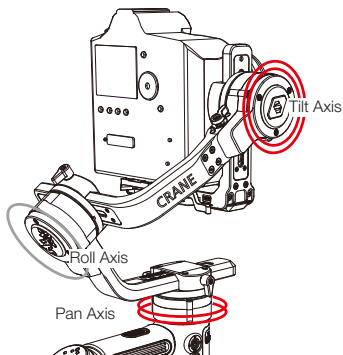

GO Mode (GO): Press and hold POV Button to enter

The camera pans left/right and tilts up/ down following the movement of the stabilizer in fast speed while the roll axis is locked.

TransMount 3S EasySling Handle Installation and Detachment

1. Mount Sling Handle Adapter Base to stabilizer with M4 wrench provided.
2. Install EasySling Handle to the adapter base.
3. Fasten EasySling Handle with the toggle on it.

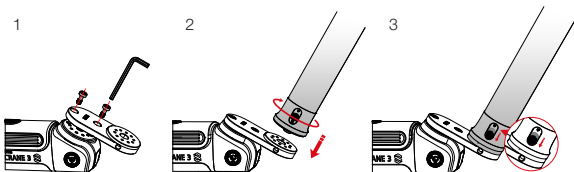

4. When detaching the EasySling Handle, push the toggle to release the handle and remove adapter base from stabilizer with M4 wrench.

TransMount CRANE 3S SmartSling Handle Installation and Detachment

1. Slide the protective cover at the bottom of battery compartment open.
2. Insert SmartSling Handle to the slot.
3. Make sure safety lock is engaged before pull the latch close to battery compartment bottom.

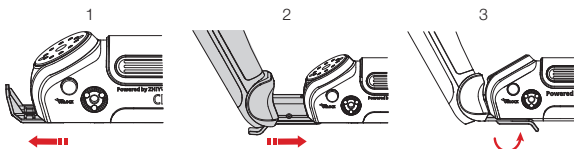

4. When detaching the SmartSling Handle, unlock the latch and then press the safety lock while pulling out the SmartSling Handle.

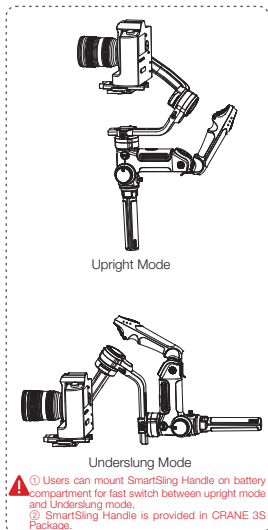
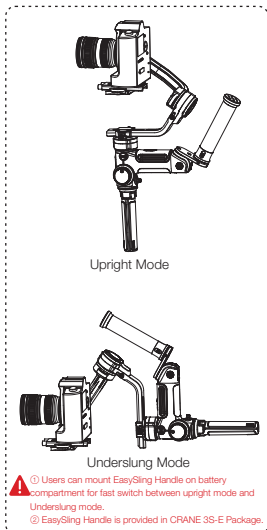

Extension Arm Installation and Detachment

1. Remove 4 M3 screws on horizontal arm of stabilizer with M2.5 wrench.
2. Remove wire cover set screws with M1.3 wrench.

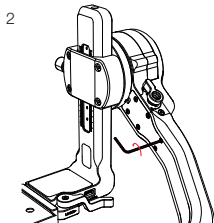
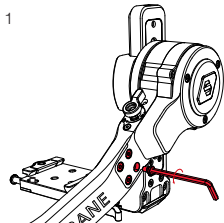

3. Pull out the tilt axis motor and wire cover (Be careful not to break or damage the wires inside).
4. Remove the rubber cover on the extension arm and install the extension arm on the horizontal arm.

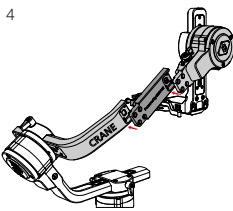
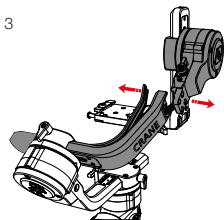

5. Install the M3 screws provided and removed in Step 1 to the horizontal arm.
6. Make sure all the wires are inside the horizontal arm and then install the wire cover to the horizontal arm. Tighten the set screws and install the rubber cover to the horizontal arm.

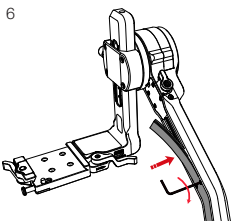
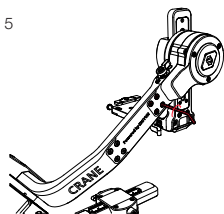

⚠ Be careful not to squeeze or overstretch the wires during the installation. For extension arm installation tutorial, please visit the official website of ZHIYUN at www.zhiyun-tech.com.

7. Please follow the steps below when detaching the extension arm: ① remove the 8 M3 screws on extension arm with M2.5 wrench; ② remove wire cover set screws with M1.3 wrench; ③ pull out tilt axis motor; ④ Remove wire cover and rubber cover; ⑤ detach extension arm; ⑥ attach tilt axis motor to horizontal arm; ⑦ fold up the wires and install the wire cover on horizontal arm.

7

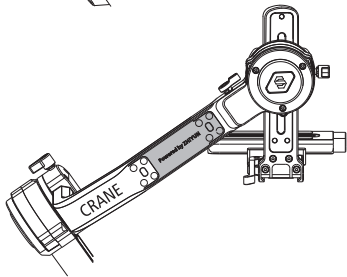
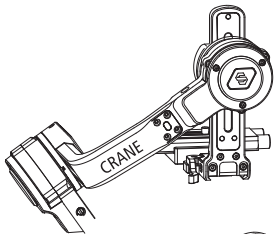
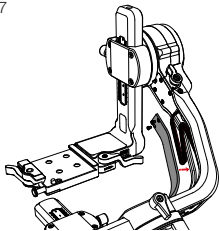

- 💡 Users can add the extension arm provided to the horizontal arm to fit more camera-lens combos.

Manual Angle Lock

Under pan following mode (PF) and locking mode (L), you can manually rotate the camera to a certain angle, then loosen the grip and the camera position will be fixed. Under pan following mode (PF), you can manually adjust the angle of tilt axis. Under locking mode (L), you can manually adjust the angle of pan axis and tilt axis.

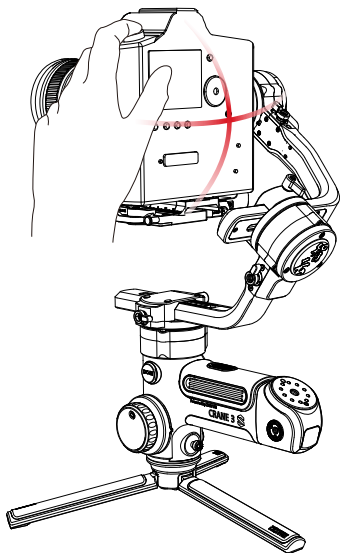

Download APP



Scan the QR code on the left (Android 5.0 and above, iOS 9.0 and above required) or search "ZY Play" in App Store or Google Play to download.

- ⚠️ ① Users will be able to make better use of the various functions of CRANE 3S paired with ZY Play that exclusively designed for it.
- ② ZY Play is subject to regular update without prior notice.

How to Connect Stabilizer to Smartphone

1. Power on the stabilizer and connect the stabilizer with your camera with a camera control cable. Turn on your phone Bluetooth.
2. Open "ZY Play" and choose the corresponding product page for CRANE 3S. Tap "Connect" to connect with the stabilizer via the corresponding Bluetooth name. (Please check the USER ID: XXXX on the bottom of the quick-release plate to find the stabilizer Bluetooth name, or check it on "Menu"->"about".)

Overview of the Main Functions



When do you need to calibrate the stabilizer?

Please calibrate the stabilizer when necessary.

When	How
1. Slight deviation is found in the tilt angle of the camera in level position after turning on. 2. Slight deviation is found in the roll angle of the camera in level position after turning on. 3. Frequent small angle correction is found when the camera is in level position while the stabilizer stays still.	Initializing the stabilizer
1. Slight deviation is found in the level position after the initialization of the stabilizer. 2. The stabilizer has not been used for a long time. 3. The stabilizer undergoes significant temperature difference in operation environments	Six-side calibration
Slight deviation is found in the tilt or roll angle of the camera in level position after initialization and six-side calibration of the stabilizer.	Fine tuning the motors

Initialization Method

1. Correctly install the batteries.
2. Hold the quick release plate with one hand. Long press the power button to turn on stabilizer. After powering on the stabilizer, motors will produce forces. Please hold tight the quick release plate and long press MODE button to enable the stabilizer to enter standby mode.
3. Put the stabilizer still on a flat surface, and wait for about 30 sec., and the stabilizer will automatically complete initialization.

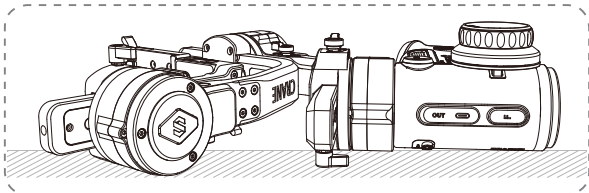

Six-side Calibration

1. Six-side calibration via APP:

According to the method introduced in "APP Operations", please connect the stabilizer with APP, and enter "Six-side Calibration", then conduct the six-side calibration according to the prompt.

2. Six-side calibration via "Zhiyun Gimbal Tools":

Power on the stabilizer and turn it to standby mode. Connect the USB port on the stabilizer with a computer via a Type-C USB cable. Launch Zhiyun Gimbal Tools, click "open" on the top and click "calibration" on the bottom. Please conduct the process according to the following steps. A "√" mark will appear after the calibration is completed.

3. Six-side calibration via OLED display guide:

Connect the stabilizer with SmartSling Handle, power on the stabilizer and enter standby mode, then press menu and rotate the dial to "calibration" option. Single press Right to confirm the selection, and single press "yes" to start. Conduct the steps appearing on the stabilizer display screen. After the calibration is completed, a "√" mark will appear on the display screen.

- ① Please refer to the six-side calibration steps below. After the calibration is completed, please restart the stabilizer.
- ② In simple terms, six-side calibration is to place all six sides of the camera mounting plate in vertical to a level surface respectively

STEP 1

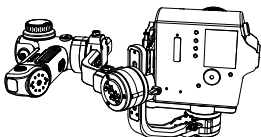

STEP 2

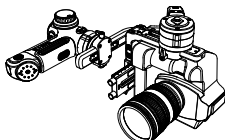

STEP 3

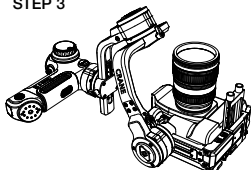

STEP 4

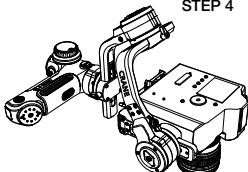

STEP 5

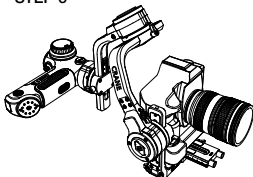

STEP 6

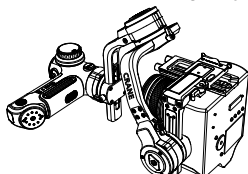

Motor Fine-tuning

According to the method introduced in "APP Operations", please connect the stabilizer with APP, and enter "Settings" and select "motor calibration", then set the fine-tuning value of the tilt axis and roll axis according to actual needs.

Stabilizer Firmware Update

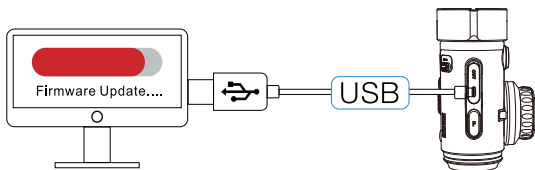

Method 1: Connect the USB port on the stabilizer with a computer via a Type-C USB cable to conduct the stabilizer firmware update and online calibration.

1. Open ZHIYUN official website www.zhiyun-tech.com. Click "Download"- "Firmware" on the homepage. Find and download the USB driver and the latest firmware for your stabilizer model. (For Mac and WIN10, you don't need to download USB driver.)
2. Install the downloaded driver.
3. Power on the stabilizer and enter standby mode.
4. Launch "Zhiyun Gimbal Tools", then conduct firmware update according to the operations in the firmware update tutorial.

Method 2: Update via APP. According to the method introduced in "APP Operations", connect the stabilizer to APP. If a firmware update prompt pops up on APP, please tap to update.

- ⚠ Before the firmware update, please ensure that the power level of both stabilizer and phone remain above 50%. Do not exit APP or move APP to the background. Please pay attention to the APP prompt information.

Product Model: CR107

Technical parameter				
Projects	Min.	Standard	Max.	Remark
Operation Voltage	9.8V	11.1V	25.2V	
Operation Current	360mA	-	5400mA	
Tilt Mechanical Range	-	360°	-	Unlimited Rotation
Roll Mechanical Range	-255°	330°	+75°	
Pan Mechanical Range	-	360°	-	Unlimited Rotation
Operation Temperature	-10°C	25°C	45°C	
Battery Capacity		2600mAh		Three 18650 Li-Ion Batteries
Battery Runtime		12h		Lab Data 1
Charging Time		4h		Lab Data 2
Weight		≈ 2470g		Excluding Extension Arm
Quick Release Plate Weight		≈ 130g		Excluding Lens Support Tube
Battery Weight		≈ 140g		
Tripod Weight		≈ 260g		
Payload	600g		6500g	Camera backing base is needed when mounting camera-lens combos with weights close to minimum payload.
Bluetooth			Bluetooth 5.0	
Camera Charging			Support camera charging at a level of 5V/1A	
Bearing Range of 1/4" Screw Thread with Crown Gear		Load Capacity ≤ 1000g, Moment Arm Length ≤ 100mm		Use of the 1/4" Screw Thread with Crown Gear should never exceed its limitations.

Lab Data 1: This data is collected at a specified temperature of 25°C . Mounted with Canon 5D4 + 24-70mm F2.8L lens, TransMount Follow Focus Controller, Zoom Controller, SmartSling Handle and TransMount Image Transmission Transmitter, fully charged 18650-2600mAh 3.6V 9.36Wh batteries, the stabilizer was properly balanced and put on a flat surface. The stabilizer battery can last for 12 hours with low motor torque.

Lab Data 2: This test is conducted with a 5V/2.4A rated power adapter at a specified temperature of 25°C . The actual charging time in this test is 4 hours. However, charging time varies with environmental factors. In addition, the lower the temperature, the longer the charging will take.

All the data in this guide is gathered from internal experiments of ZHIYUN laboratories. Under different scenarios, data is different to some extent. Please refer to the actual use of CRANE 3S.

Thank you for purchasing ZHIYUN CRANE 3S. The information contains herein affects your safety, legitimate rights and obligation. Please read this instruction carefully to ensure proper configuration before use. Failure to read and follow this instruction and warnings herein may result in serious injury to you or bystanders, or damage to your device or property. Guilin Zhishen Information Technology Co., Ltd reserves all rights for final explanation on this instruction and other documents related to CRANE 3S. The information is subject to update without notice. Please visit www.zhiyun-tech.com to obtain the latest product information.

By using this product, you hereby signify that you have read this document carefully and that you understand and agree to abide by the terms and conditions herein. You agree that you are solely responsible for your own conduct while using this product, and for any consequences thereof. You agree to use this product only for purposes that are proper and in accordance with all terms, precautions, practices, policies and guidelines ZHIYUN has made and may make available.

ZHIYUN accepts no liability for damage, injury or any legal responsibility incurred directly or indirectly from the use of this product. Users shall observe safe and lawful practices including, but not limited to, those set forth herein.

ZHIYUN™, TransMount™ are the trademark of Guilin Zhishen Information Technology Co., Ltd. (hereinafter referred to as "ZHIYUN" or "ZHIYUN TECH") and its affiliates. All product names or marks referred to herein are trademarks or registered trademarks of their respective holders.

Reading Tips

Legends:  Hints and Tips  Important

Scan the QR code and operate under carrier network may cause traffic fee which will be charged by your network carrier. It is recommended to operate under WIFI.

Warnings

Read the ENTIRE User Guide to become familiar with the features of this product before operating. Failure to operate the product correctly can result in damage to the product or personal property and cause serious injury. This is a sophisticated product. It must be operated with caution and common sense and requires some basic mechanical ability. Failure to operate this product in a safe and responsible manner could result in injury or damage to the product or other property. This product is not intended for use by children without direct adult supervision. DO NOT use with incompatible components or in any way otherwise as mentioned or instructed in the product documents provided by ZHIYUN. The safety guidelines herein contain instructions for safety, operation and maintenance. It is essential to read and follow all of the instructions and warnings in the User Guide, prior to assembly, setup or use, in order to operate the product correctly and avoid damage

Safe Operation Guidelines

■ CAUTION:

1. CRANE 3S is a high-precision control device. Damage may be caused to CRANE 3S if it is dropped or subject to external force, and this may result in malfunction.
2. Make sure the rotation of the gimbal axes is not blocked by external force when CRANE 3S is turned on.
3. CRANE 3S is not waterproof. Prevent contacts of any kind of liquid or cleaner with CRANE 3S. It is recommended to use dry cloth for cleaning.
4. Protect CRANE 3S from dust and sand during use.

■ WARNING

To avoid fire, serious injury, and property damage, observe the following safety guidelines when using, charging, or storing your batteries.

Battery Use

1. Prevent the batteries to come into contact with any kind of liquid. Do not leave batteries out in the rain or near a source of moisture. Do not drop the battery into water. If the inside of the battery comes into contact with water, chemical decomposition may occur, potentially resulting in the battery catching on fire, and may even lead to an explosion.
2. If the battery falls into water with the stabilizer during use, take it out immediately and put it in a safe and open area. Maintain a safe distance from the battery until it is completely dry. Never use the battery again, and dispose of the battery properly as described in the Battery Disposal section below.
3. If the battery catches fire, use water, water spray, sand, fire blanket, dry powder, or carbon dioxide fire extinguisher immediately to put out the fire. Battery-caused fire may lead to explosion. Please extinct the fire by applying the methods recommended above according to the actual situation.
4. Never use non-ZHIYUN batteries. If replacement or backup is needed, please purchase new batteries from ZHIYUN's official website or authorized channels. ZHIYUN takes no responsibility for any damage caused by non-ZHIYUN batteries.
5. Never use or charge swollen, leaky, or damaged batteries. Never use or charge if the battery smells, or overheats (exceeding maximum temperature of 160 ° F/71 ° C). If your batteries are abnormal, contact ZHIYUN or a ZHIYUN authorized dealer for further assistance.
6. The battery should be used within the temperature range from -10° C to 60° C. Use of battery in environments above 60° C may lead to a fire or explosion. Use of battery below -10° C may lead to serious battery damage.
7. Do not use the battery in strong electrostatic or electromagnetic environments. Otherwise, the battery protection board may malfunction.
8. Do not disassemble or use any sharp object to puncture the battery in any way. Otherwise, the battery may leak, catch fire or explode.
9. Do not mechanically strike, crush, or throw the battery. Do not place heavy objects on the battery or charger.
10. Electrolytes inside the battery are highly corrosive. In case of accidental contact of any electrolytes with your skin or eyes, rinse immediately with water for at least 15 minutes and seek medical advice as soon as possible.
11. Do not use the battery if it has been involved in a crash or heavy impact.
12. Do not heat the battery and never put the battery in a microwave oven or in a pressurized container.

13. Do not place the battery on a conductive surface (such as a metal desk surface, eye-glasses, watch, jewelry, etc.)
14. Prevent use of wires or other metal objects that could cause positive and negative short-circuit to the battery.
15. If the battery terminal is dirty, wipe it with a clean, dry cloth. Otherwise it will cause a bad battery connection, which may result in energy loss or charging failure.

Battery Charging

1. The battery will automatically stop charging once it is full. Please disconnect the battery and the charger when fully charged.
2. Do not attach the batteries to a wall outlet or car charger socket directly. Always use a ZHIYUN approved adapter for charging. ZHIYUN takes no responsibility if the battery is charged using a non-ZHIYUN charger.
3. Do not put the battery and charger near flammable materials or on flammable surfaces (such as carpet or wood). Never leave the battery unattended during charging to prevent any accident.
4. Do not charge the battery immediately after use, because the battery temperature may be too high. Do not charge the battery until it cools down to normal room temperature. Charging the battery with its temperature over 45° C or lower than 0° C may lead to leakage, overheating, or damage.
5. Examine the charger before use, make sure there is no damage to the enclosure, cord, plug, or other parts. Never use a damaged charger. Do not clean the charger with any liquid containing alcohol or other flammable solvents. Disconnect the charger when not in use.

Battery Storage

1. Keep batteries out of the reach of children and pets.
2. Do not leave the battery near heat sources such as a furnace or heater, or inside of a vehicle on hot days. Never expose the battery in any environment with temperature of over 60° C. The ideal storage temperature is 22° C-28° C.
3. Store batteries in a dry environment.
4. Do not leave the battery unused for too long after it has been completely discharged to prevent over-discharge of battery which may result in battery damage and permanent failure.

Battery Maintenance

1. Do not over-charge or over-discharge the battery, which will damage the battery;
2. The battery performance will be affected for not being used for a long time;
3. Never use the battery when the temperature is too high or too low;
4. Do not store the battery in any environment with a temperature of over 60°C .

Battery Disposal

1. Please fully discharge the battery before putting it in the designated recycling bin. Batteries contain hazardous constituents and it is forbidden to put the battery in general waste bin. For related details please abide by the local laws and regulations on battery recycling and disposal.
2. If the battery cannot be fully discharged, never put it in battery recycling bin. Please contact battery recycling companies for a proper solution.

Warranty Period

1. Customers are entitled to replacement or free repair service in case of quality defect(s) found in the product within 15 days upon receipt of the product.
2. Customers are entitled to free repair service from ZHIYUN for any product proven defective in material or workmanship that results in product failure during normal consumer usage and conditions within the valid warranty period, which is 12 months counting from the date of selling. However, warranty period varies by product component and country of purchase. Please contact our after-sales service team on ZHIYUN official website or your place of purchase for detailed warranty information.

Warranty Exclusions

1. Products subjected to unauthorized repair, misuse, collision, neglect, mishandling, soaking, accident, and unauthorized alteration.
2. Products subjected to improper use or whose labels or security tags have been torn off or altered.
3. Products whose warranty has expired.
4. Products damaged due to force majeure, such as fire, flood, lightening, etc.

Warranty Claim Procedure

1. If failure or any problem occurs to your product after purchase, please contact a local agent for assistant, or you can always contact ZHIYUN's customer service through email at service@zhiyun-tech.com or website at www.zhiyun-tech.com.
2. Your local agent or ZHIYUN's customer service will guide you through the whole service procedure regarding any product issue or problem you have encountered. ZHIYUN reserves the right to reexamine damaged or returned products.

Customer information

Customer Name : Contact No :

Address :

Sales Information

Sales Date : Prod. Serial No :

Dealer :

Contact No ::

#1 Maintenance Record

Service Date : Signature of Repairman :

Cause of Problem :

Service Result : Solved Unsolved Refunded (Replaced)



Website



Weibo



Vimeo



Google+



Facebook
(Zhiyun Support)



Facebook
(Zhiyun Tech)



Youku



Youtube



Wechat



Instagram

Tel: +86 (0) 773-3561275

USA Hotline: +1 808-319-6137,9:00-18:00 GMT-7,Mon-Fri

Europe Hotline: +49 (0) 61018132180,10:00-17:00 GMT+1,Mon-Fri

Web: www.zhiyun-tech.com

E-mail: service@zhiyun-tech.com

Address: 09 Huangtong Road, Tieshan Industrial Zone, Qixing District, Guilin, Guangxi, China.

Certificate of Quality

This product is confirmed to meet quality standards and permitted for sale after strict inspection.

QC Inspector: _____



Please download the latest version from www.zhiyun-tech.com

This document is subject to change without notice.

ZHIYUN™ is a trademark of ZHISHEN.

All other trademarks cited herein are the property of their respective owners.

Copyright © 2020 ZHISHEN. All rights reserved.

ZHIYUN-TECH.COM